

Pedestrian stacker truck 1.0 ton



BT staxio

W-series

SWE100



Pedestrian stacker

Specification for stacker trucks						SWE100
Identification	1.1	Manufacturer				Toyota
	1.2	Model				SWE100
	1.3	Drive				Electric
	1.4	Operator type				Pedestrian
	1.5	Load capacity/rated load	Q	kg		1000
	1.6	Load centre	c	mm		600
	1.8	Load distance, centre of support arm wheel to face of forks	x	mm		663
	1.9	Wheelbase	y	mm		1195
	Weight	2.1	Service weight including battery		kg	
2.2		Axle load, with load, drive/castor/support arm wheel		kg		350/280/1185
2.3		Axle load, without load, drive/castor/support arm wheel		kg		350/230/235
Wheels	3.1	Drive/castor/fork wheel				Polyurethane
	3.2	Wheel size, front		mm		Ø230x70
	3.3	Wheel size, rear		mm		Ø85x95
	3.4	Additional wheels (dimensions)		mm		Ø125x50
	3.5	Wheels, number front/rear (x=driven wheels)				1x+2/2
	3.6	Track width, front	b ₁₀	mm		550
	3.7	Track width, rear	b ₁₁	mm		390
Dimensions	4.2	Height, mast lowered	h ₁	mm		2143 *)
	4.3	Free lift	h ₂	mm		76 *)
	4.4	Lift	h ₃	mm		3210 *)
		Lift height	h ₂₃	mm		3300 *)
	4.5	Height, mast extended	h ₄	mm		3720 *)
	4.8	Stand height (optional platform)	h ₇	mm		150
	4.9	Height of tiller in drive position without platform, min./max.	h ₁₄	mm		865/1235
		Height of tiller in drive position with platform, min./max.	h ₁₄	mm		1055/1235
	4.15	Height, fork lowered	h ₁₃	mm		90
	4.19	Overall length	l ₁	mm		1831
	4.20	Length to face of forks	l ₂	mm		683
	4.21	Overall width	b ₁	mm		770
	4.22	Fork dimensions	s/e/l	mm		60/180/1150 *)
	4.24	Fork-carriage width	b ₃	mm		674
	4.25	Width over forks	b ₅	mm		570 *)
	4.31	Ground clearance, with load, below mast	m ₁	mm		27
	4.32	Ground clearance, centre of wheelbase	m ₂	mm		27
4.34.1	Aisle width for pallets 1000x1200 crossways	A _{st}	mm		2234	
4.34.2	Aisle width for pallets 800x1200 lengthways	A _{st}	mm		2216	
4.35	Turning radius	W _a	mm		1346	
Performance data	5.1	Travel speed, with/without load		km/h		6/6
	5.2	Lift speed, with/without load		m/s		0.25/0.12
	5.3	Lowering speed, with/without load		m/s		0.34/0.39
	5.8	Max. gradeability, with/without load ²⁾		%		8/12 ¹⁾
	5.10	Service brake				Electromagnetic
Electric motor	6.1	Drive motor rating S2 60 min		kW		1.0
	6.2	Lift motor rating at S3 15%		kW		2.2 ²⁾
	6.4	Battery voltage/nominal capacity K ₅		V/Ah		24/150 *)
	6.5	Battery weight		kg		144 ¹⁾
	6.6	Energy consumption according to VDI cycle		kWh/h		0,49
		Energy consumption acc. to EN16796:2016		kWh/h		0,42
	6.7	Turnover output		t/h		36,9
	6.8	Energy consumption at turnover output		kWh/h		0,81
Other	8.1	Type of drive control				Variable AC

¹⁾ Measured according to company standard

²⁾ S3 6%

*) Further alternatives are available and will produce other values.

Data is based on standard configurations: Small battery compartment, h₂₃ = 3300 mm Duplex Tele mast.

All data are based on table configuration. Other configurations may give other values.

Truck performance and dimensions are nominal and subject to tolerances.

Toyota Material Handling Manufacturing Sweden AB products and specifications are subject to change without notice.

Battery dependent dimensions

BT staxio

Dimensions		Battery Compartment		SWE100		
				Small	Medium	Large
1.9	Wheelbase	y	mm	1195	1252	1302
4.19	Overall length	l ₁	mm	1831	1888	1938
	... without platform		mm	1916/2306	1973/2363	2023/2413
4.20	Length to face of forks	l ₂	mm	681	738	788
	without platform		mm	766/1156	823/1213	873/1263
4.34.1	Aisle width for pallets 1000x1200 crossways	A _{st}	mm	2234	2291	2341
	without platform		mm	2319/2719	2376/2776	2426/2826
4.34.2	Aisle width for pallets 800x1200 lengthways	A _{st}	mm	2216	2273	2323
	without platform		mm	2301/2701	2358/2758	2408/2808
4.35	Turning radius, forks raised	W _a	mm	1346	1403	1453
	without platform		mm	1431/1831	1488/1888	1538/1938
6.4	Battery voltage, nominal capacity, Lead-Acid	K ₅	V/Ah	24/150	24/225	24/300
	Battery voltage, nominal capacity, Li-Ion	K ₅	V/Ah	24/105	-	24/210
6.5	Battery weight, nominal		kg	144	192	248
	Battery weight, min. - max.		kg	139 - 285	139 - 285	139 - 285

Master dimensions

SWE100			Simplex		Duplex Tele			Duplex Tele Panoramic View		
h ₂₃	Lift height (h ₁₃ +h ₃)	mm	1400	1700	2700	2900	3300	2700	2900	3300
h ₃	Lift	mm	1310	1610	2610	2810	3210	2610	2810	3210
h ₁	Height, mast lowered	mm	1825	2125	1848	1948	2148	1843	1943	2143
h ₂	Free lift, ground to top of forks	mm	1400	1700	76	76	76	76	76	76
h ₄	Height, mast extended	mm	1825	2125	3125	3325	3725	3120	3320	3720

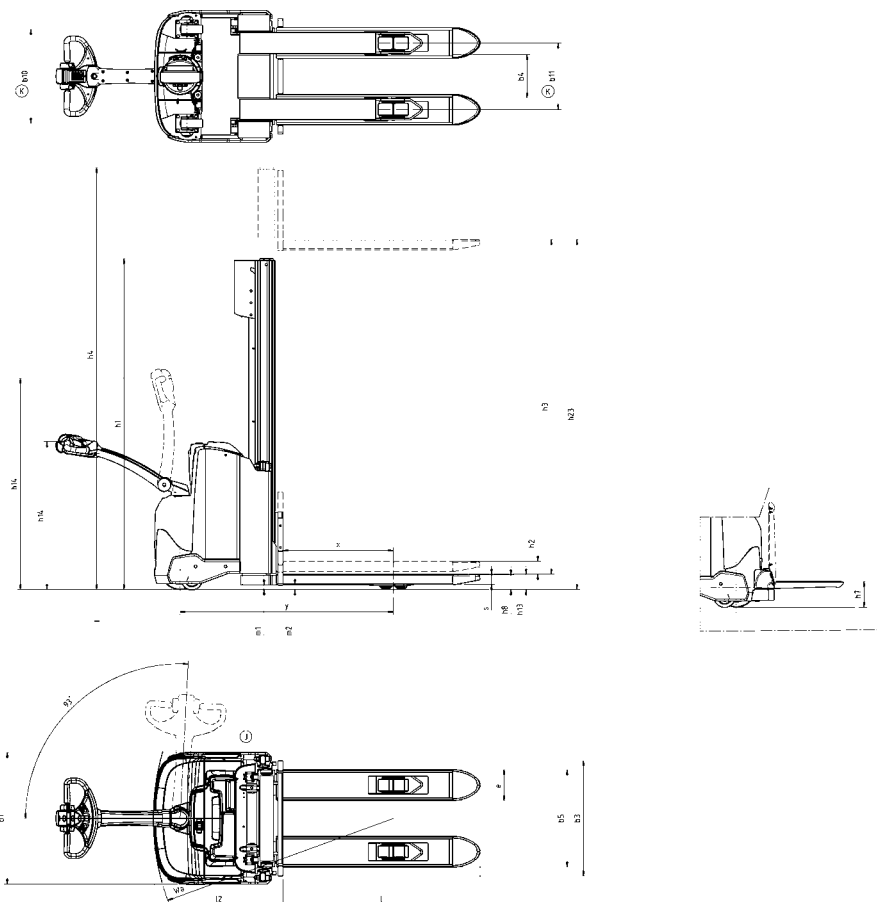

Truck features:

- BT Powerdrive System
- Fingertip controls
- Electronic braking system
- Electronic speed control
- Operator safety
- Storage compartments
- Automatic switch-off
- Click-2-creep
- Programmable performance
- Easy access for maintenance
- Built in charger (option)
- Flip-up operator platform (option)
- Toyota I_site: truck fleet management system (option)
- Hydraulic oil for low temperatures (option)

